

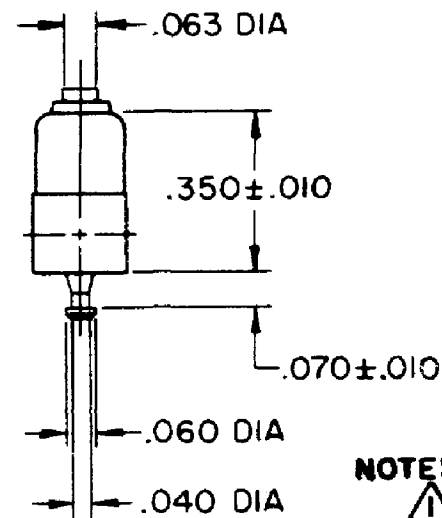

HONEYWELL PART NUMBER
4SX36-T
PRODUCT CODE VDF0960
FAA-PMA 

REV	DOCUMENT	CHANGED BY	CHECK
10	0038447	SS 28MAR08	BLR

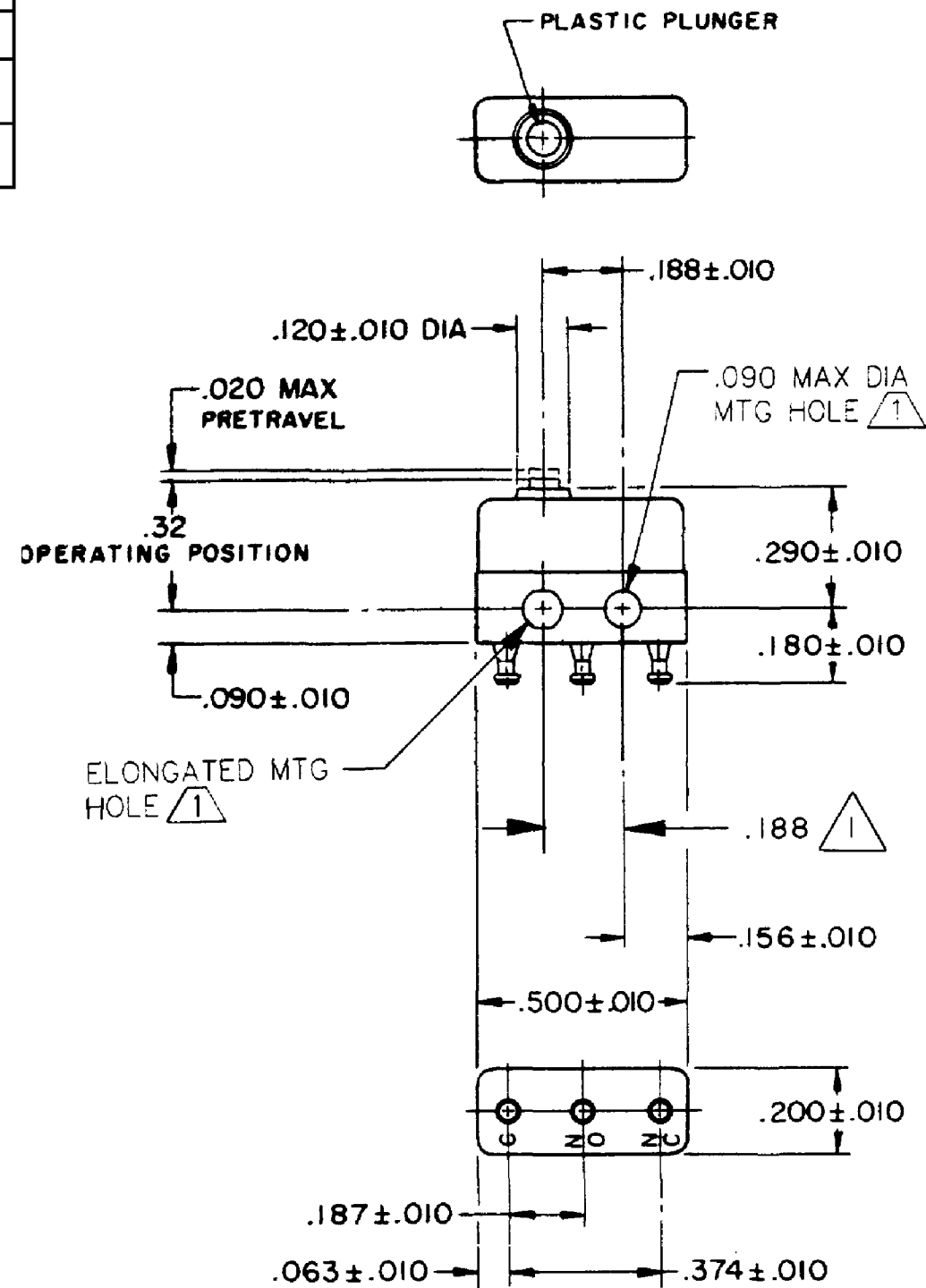



NOTES

-  MOUNTING HOLES WILL ACCEPT PINS OR SCREWS OF .087 MAX DIA ON .188 ± .002 CENTERS
- 2- TERMINALS ARE PLATED FOR SOLDERING
- 3- SWITCH WILL WITHSTAND TEMPERATURE OF 400°F
- 4- SWITCH HAS A GREATER OVERTRAVEL THAN STANDARD CONSTRUCTION
ADDITIONAL OVERTRAVEL WILL TEND TO REDUCE MECHANICAL LIFE
-  FOR MANUFACTURING DETAIL SEE ASSEMBLY DRAWING 4SX36-T FOR FAA-PMA

RELEASE NO.	PR-253
REPLACES	

CHARACTERISTICS	
OPERATING FORCE	5 OZ MAX
RELEASE FORCE	1 OZ MIN
DIFFERENTIAL TRAVEL	.005 MAX
OVERTRAVEL	.010 MIN

ELECTRICAL DATA	
CONTACT ARRANGEMENT SPDT	
APPROVALS	KEMA, CE 7A 250V ~ T125 5E4  UL, CSA 7A 250 VAC  AVIATION FAA-PMA 

DESIGN UNITS: INCH
TOLERANCES UNLESS NOTED:
NO PLACE X ±
ONE PLACE .X ±
TWO PLACE .XX ±
THREE PLACE .XXX ±
FOUR PLACE .XXXX ±
ANGLES ±
THIRD ANGLE PROJECTION

DRAWN	SPK	06FEB08
CHECK	RJ	06FEB08
THIS DRAWING COVERS A PROPRIETARY ITEM AND IS THE PROPERTY OF HONEYWELL. THIS DRAWING IS NOT TO BE COPIED OR USED WITHOUT THE PERMISSION OF HONEYWELL.		
INTERPRET PER ANSI Y14.5M-1982 OTHER HONEYWELL ENGINEERING STANDARDS MAY APPLY		
RASTER		

Honeywell			
TITLE SWITCH - BASIC			
SIZE	TYPE	DRAWING NAME	REV
B	I	4SX36-T	10
SCALE	-	WEIGHT: .003 LB MAX	SHEET 1 OF 1